

SSL-150-ASR/SWB (150mm Swivel Stainless Steel Braked Castor Anti-Static Wheel)

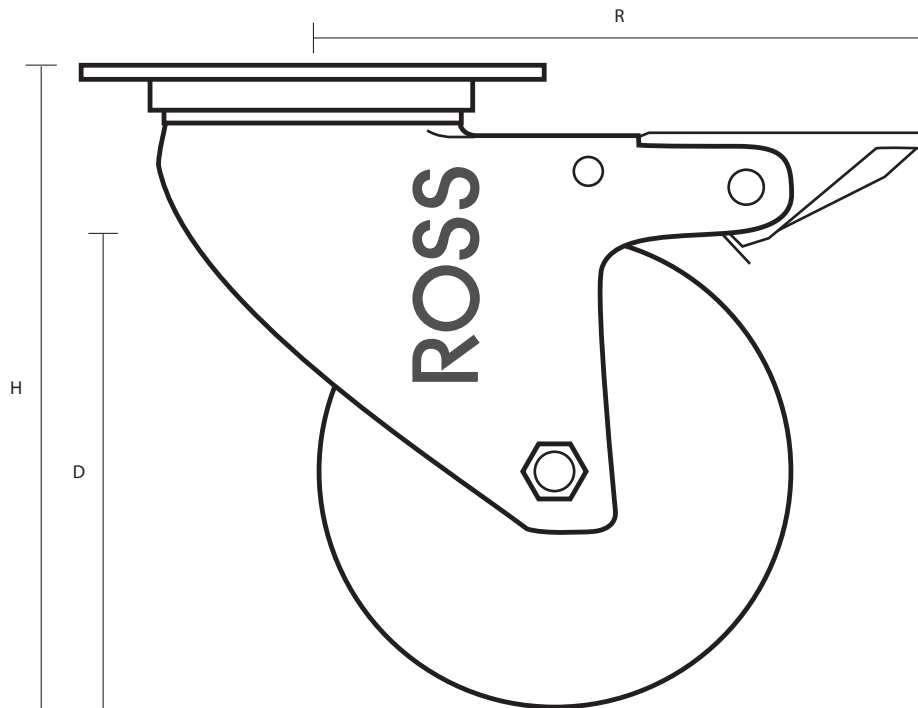
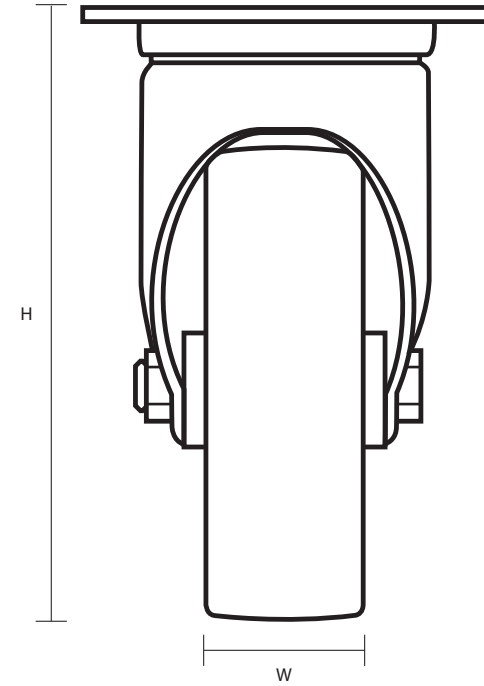
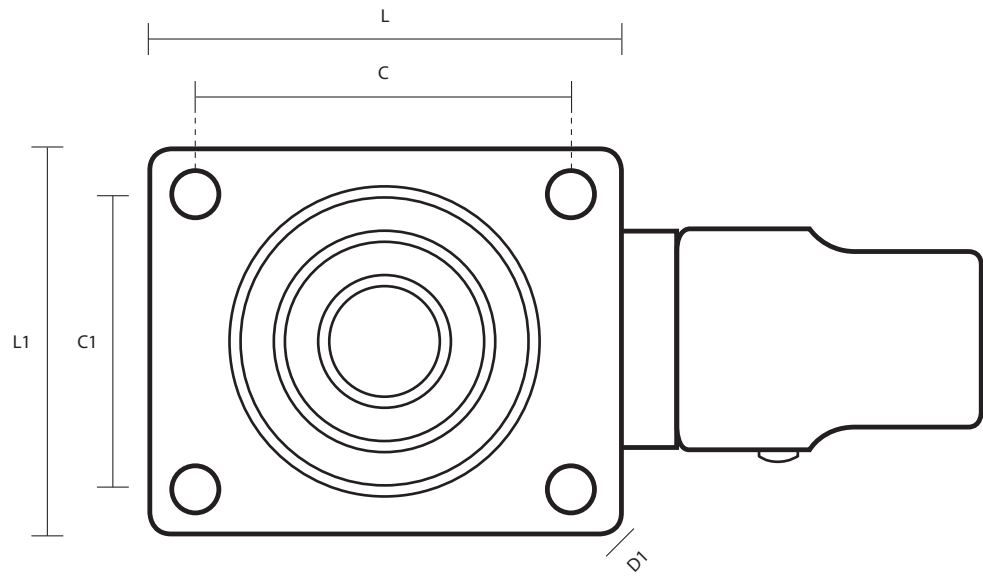

Castor Dimensions - Key

D	Wheel Diameter	150mm
L	Plate Dimension Length (mm)	90mm
L1	Plate Dimension Width (mm)	70mm
C	Plate Hole Centres length (mm)	70mm
C1	Plate Hole Centres width (mm)	50mm
D1	Plate Hole Diameter (mm)	8mm
H	Total Castor Height (mm)	188mm
W	Tread Width (mm)	30mm
R	Swivel Radius (mm)	123mm