

SS-100-TH/BH12 (100mm Swivel Castor High Temperature Phenolic Resin wheel)

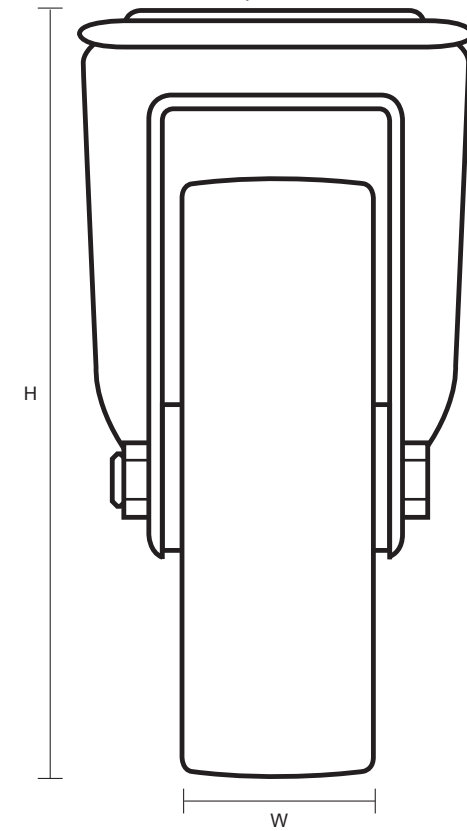
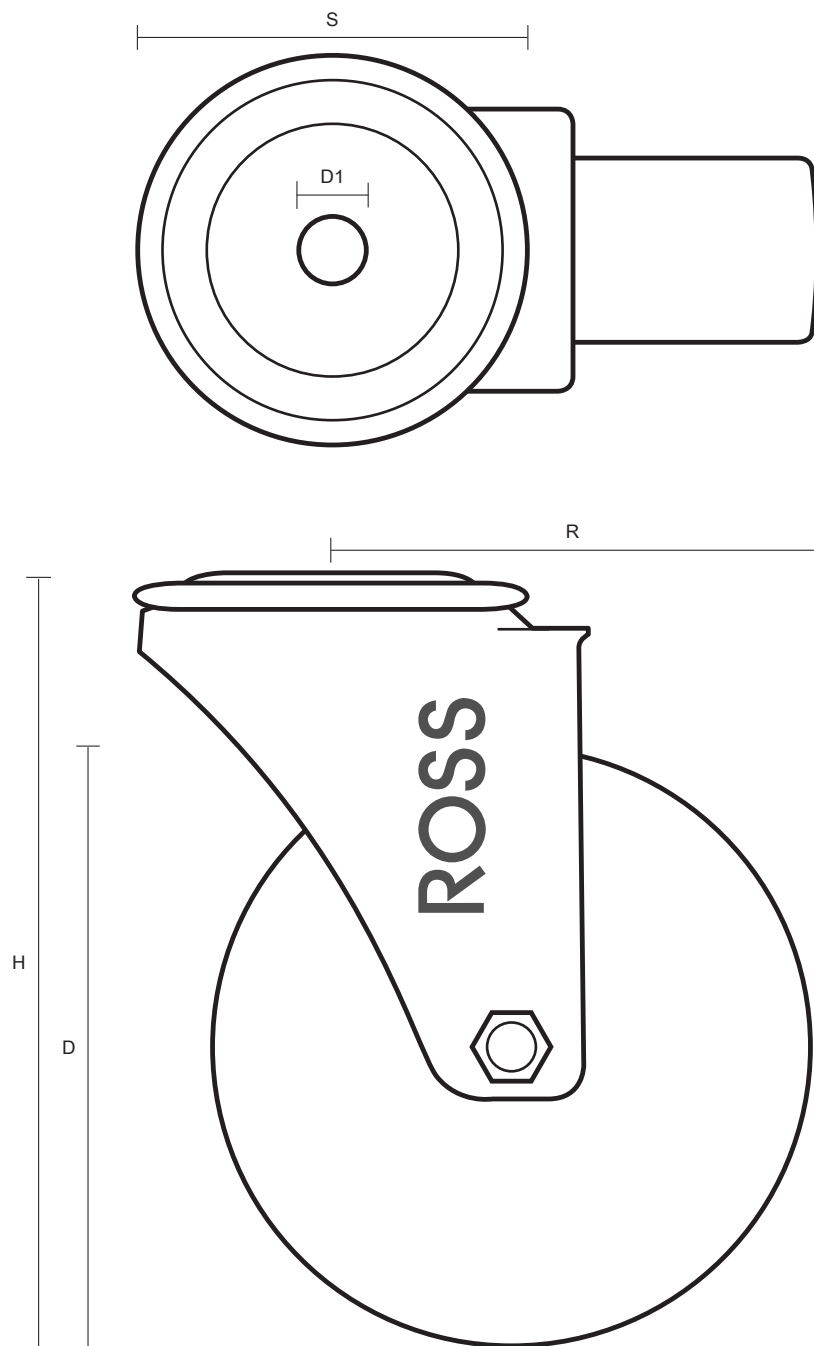

Castor Dimensions - Key

D	Wheel Diameter	100mm
L	Plate Dimension Length (mm)	N/A
L1	Plate Dimension Width (mm)	N/A
C	Plate Hole Centers length (mm)	N/A
C1	Plate Hole Centers width (mm)	N/A
D1	Plate Hole Diameter (mm)	12mm
H	Total Castor Height	128mm
W	Tread Width (mm)	35mm
R	Swivel Radius (mm)	91mm
S	Swivel Race Diameter (mm)	76mm