

ES80M10X25 (80mm Slimline Swivel Castor Grey Rubber Tyred Wheel)

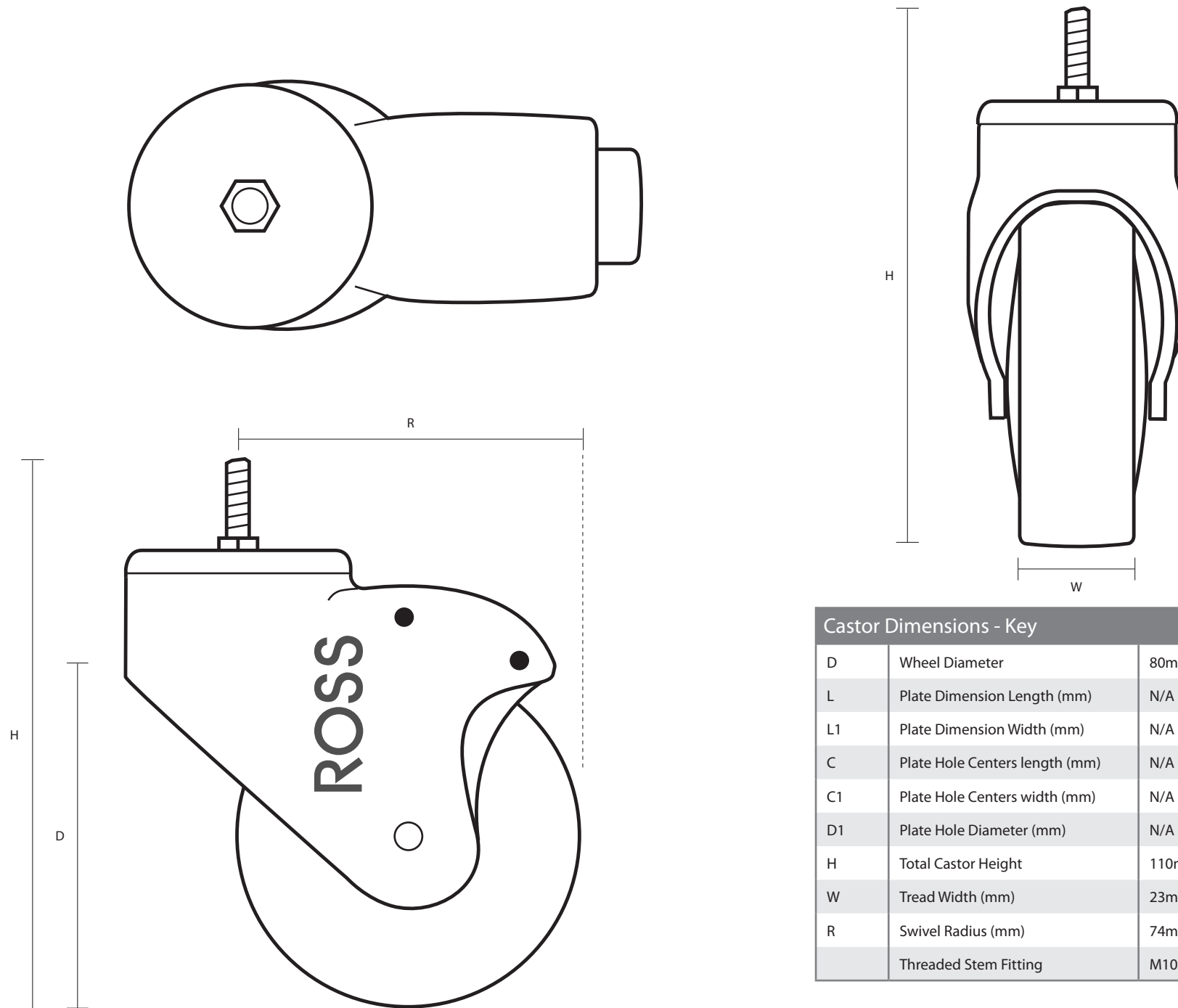

Castor Dimensions - Key		
D	Wheel Diameter	80mm
L	Plate Dimension Length (mm)	N/A
L1	Plate Dimension Width (mm)	N/A
C	Plate Hole Centers length (mm)	N/A
C1	Plate Hole Centers width (mm)	N/A
D1	Plate Hole Diameter (mm)	N/A
H	Total Castor Height	110mm
W	Tread Width (mm)	23mm
R	Swivel Radius (mm)	74mm
	Threaded Stem Fitting	M10x25mm