

80-2260-NY/SWB - (80mm Swivel Braked Castor White Nylon Wheel)

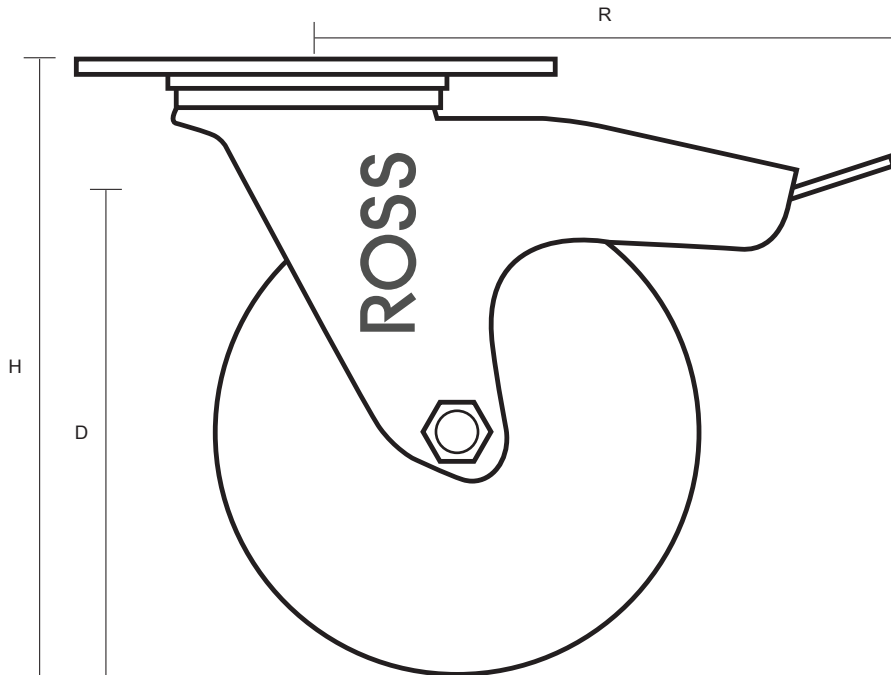
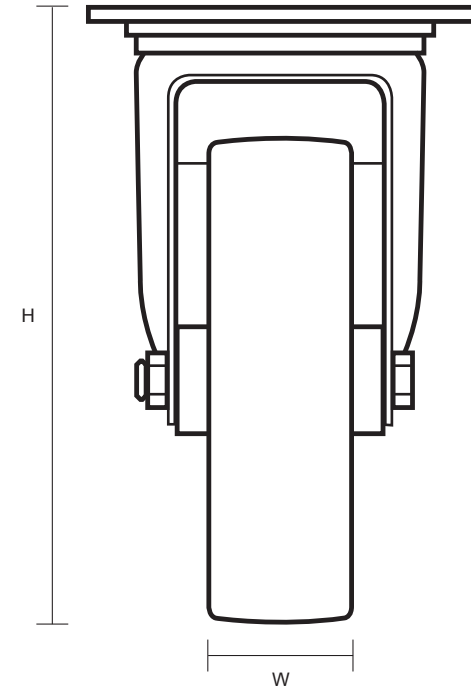
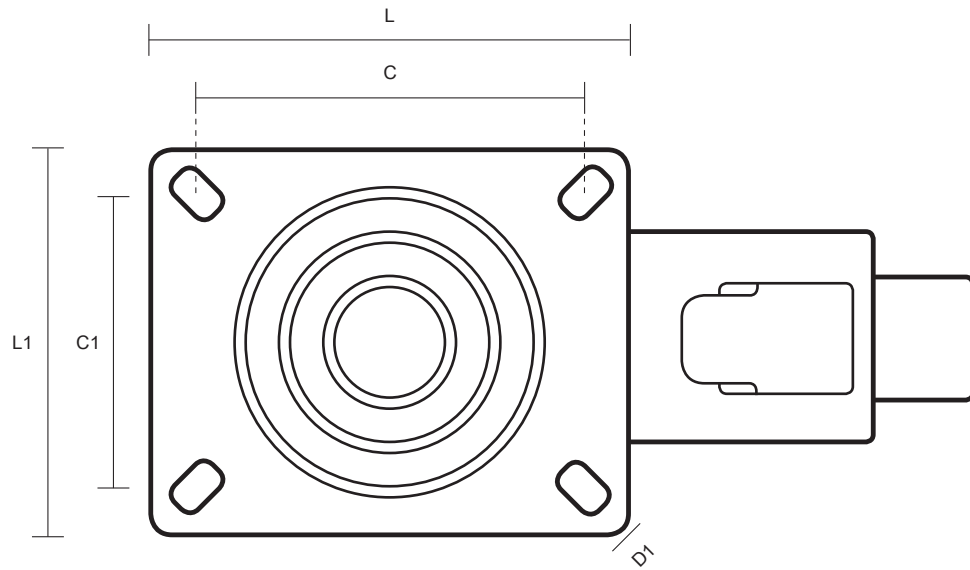

Castor Dimensions - Key

D	Wheel Diameter (mm)	80mm
L	Plate Dimension Length (mm)	99mm
L1	Plate Dimension Width (mm)	80mm
C	Plate Hole Centers length (mm)	80mm
C1	Plate Hole Centers width (mm)	60mm
D1	Plate Hole Diameter (mm)	8mm
H	Total Castor Height (mm)	107mm
W	Tread Width (mm)	30mm
R	Swivel Radius (mm)	115mm