

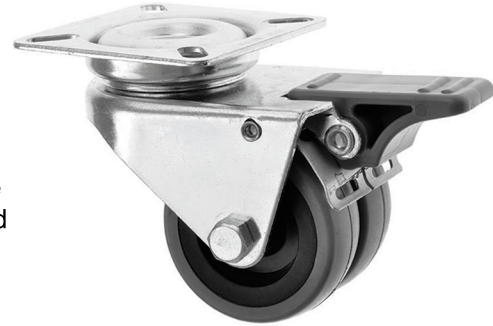















75mm Twin Wheel Grey Rubber Castor with Brake

75-360-R-FP/SWB

This 75mm twin wheeled industrial castor with a top plate fitting for easy attachment to a wide range of light duty applications. These castors come with black grey rubber for ease of movement, and the zinc plated castor housing is strong and durable. The foot operated brake simultaneously brakes both the swivel head and the wheel.



Technical Specifications

	Bearing Type	Plain
	Colour	No
	Load Capacity (kg)	90
	Max Load Capacity of 4 Castors	270
	Plate Dimension Length (mm)	60
	Plate Dimension Width (mm)	60
	Plate Hole Centres Length (mm)	48/37
	Plate Hole Centres Width (mm)	48/37
	Plate Hole Diameter	6
	Product Type	Top Plate Castors
	Swivel Radius	98
	Thread Material	No
	Total Castor Height	100
	Wheel Colour	Grey
	Wheel Diameter(mm)	75
	Wheel Material	Grey Rubber

Dimensions

