

High Temperature Castors with Phenolic Resin Wheel 100mm

100-3360-TH







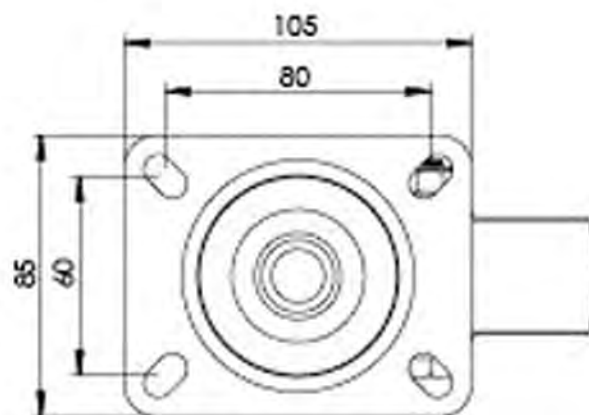
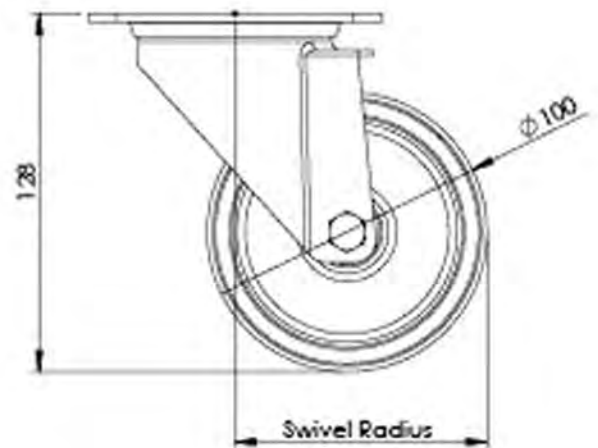













This 100mm medium duty swivel castors with a termotex phenolic resin wheel suitable for medium/heavy duty applications, medical equipment, catering equipment and food manufacturing trolleys. The zinc plated castors are strong and durable and the termotex phenolic resin wheels are resistant to temperatures from -40C to +280C maximum.



Dimensions



Technical Specifications

| | |
|--|----------------------|
|  Castor Type | Top Plate Castors |
|  Bearing Type | Plain |
|  Load Capacity (kg) | 125 |
|  Manufacturer Part No. | TSZ7 TSG 100/35 P2 |
|  Product Type | Top Plate Castors |
|  Technical PDF | 100-3360-HT_2.pdf |
|  Tread Width (mm) | 35 |
|  Temperature Range | -40 min to + 280 max |
|  Hardness of Tread | D85 |
|  Max Load Capacity of 4 Castors | 375 |
|  Plate Length (mm) | 105 |
|  Plate Width (mm) | 85 |
|  Plate Hole Centres Length (mm) | 80 |
|  Plate Hole Centres Width (mm) | 60 |
|  Plate Hole Diameter | 8 |
|  Swivel Radius | 85 |
|  Total Castor Height | 128 |
|  Wheel Colour | Black |
|  Wheel Material | Phenolic Resin |
|  Wheel Centre | Black Phenolic Resin |
|  Wheel Diameter(mm) | 100 |